



3719  
Assembly



2756, 2757 Wet-Tap  
Electrodes  
(Sold Separately)

The Signet 3719 pH/ORP Wet-Tap allows installation and removal of pH or ORP electrodes, even under process pressure, without the need for process shutdown during routine electrode maintenance and calibration. Automatic process isolation is achieved during electrode retraction with a double O-ring seal on a unique and compact retraction assembly; no separate valve is required.

A patented cam-activated automatic locking mechanism, SafeLoc™, and the short stroke design help to assure operator safety. The wet-tap unit can be mounted at any angle and can be used with the Signet DryLoc® Wet-Tap electrodes.

## Features

- Electrode removal without process shutdown
- Space saving 45 mm (1.75 in.) short-stroke design
- Sealed pneumatic dampening for smooth and safe operation
- SafeLoc™: Cam-activated automatic locking mechanism
- Protects electrode sensing surface from breakage
- Suitable for mounting in any orientation
- Process threaded connection NPT or ISO

## Applications

- Aquatic Animal Life Support Systems
- Recreational Water Monitoring
- Water & Wastewater Treatment
- Effluent Monitoring
- Neutralization Systems
- Sanitization Systems
- Pool and Spa Control

U.S. Patent No.: 6,666,701



Tel: +44 (0) 1706 869777  
E-mail: [sales@desal.co.uk](mailto:sales@desal.co.uk)  
Web: [www.desal.co.uk](http://www.desal.co.uk)



# Specifications

General		
Compatible DryLoc® Electrodes	2756-WT, 2756-WT-1	glass
	2756-WTP, 2756-WTP-1	plastic
	2757-WT	glass
	2757-WTP	plastic
Process Connection	3719-11	NPT 1½ in.
	3719-21	NPT 2 in.
	3719-12	ISO 7/1 - R 1.5
	3719-22	ISO 7/1 - R 2
Maximum Flow Velocity	3 m/s	10 ft/s
Materials		
Retraction Housing (Wetted)	CPVC	
O-rings (Wetted)	FPM	
Locking Shroud	PVC	
Hardware	316 stainless steel	
Max. Temperature/Pressure Rating		
Operating Pressure	100 psi (6.9 bar) maximum @ 25 °C	
Shipping Weight		
	1.2 kg	2.7 lb
Standards/Approvals		
	Manufactured under ISO 9001 for Quality, ISO 14001 for Environmental Management and OHSAS 18001 for Occupational Health and Safety	

See Temperature and Pressure graphs for more information

## Wet-Tap Installation

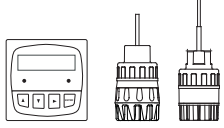
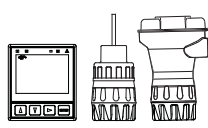
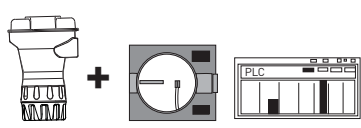
System Overview

Panel Mount	4 to 20 mA Input
<p>Signet Instrument 8750 with 2760 Preamplifier 8900 9900 with 2750 Sensor Electronics</p> <div style="text-align: center;">  <span style="font-size: 24px; font-weight: bold; margin: 0 10px;">OR</span>  </div>	<p>3-2750 Sensor Electronics and customer supplied Chart Recorder or Programmable Logic Controller</p> <div style="text-align: center;">  </div>
<p><b>Signet Model 3719 Wet-Tap Assembly</b> with Wet-tap electrode 3-2756-WT, 3-2756-WTP 3-2757-WT or 3-2757-WTP</p> <div style="text-align: center;">  </div> <p style="text-align: right; margin-top: 10px;">All sold separately</p>	
<p>Customer supplied tees and fittings</p>	

# Specifications

## 2756-WT and 2757-WT pH/ORP Wet-Tap Electrodes

### General

Compatibility	Signet 3719 Wet-Tap Assembly, 2750 Sensor Electronics or 2760 Preamplifier	
Operating Range	pH	0 to 14 pH
	ORP	Application dependent
Connector	CPVC	DryLoc®
Temperature Sensor (pH)	PT1000 or 3K Balco for pH	
Reference Junctions	Porous PTFE	
	Electrolyte	Saturated KCl
	Elements	Ag/AgCl
Performance		
	Efficiency	> 97% @ 25 °C (77 °F)
Response Time		
	pH	< 5s for 95% of signal change
	ORP	Application dependent
Impedance (pH)	< 150 MΩ @ 25 °C	

### Wetted Materials

Body	Glass or PAS (Polyaryl sulphone)	
Reference Junctions	Porous PTFE	
Sensing Surface	pH	Glass membrane
	ORP	Platinum
O-rings	FPM	
Connector	CPVC	

### Max. Temperature Rating

Operating Temperature	0 °C to 85 °C	32 °F to 185 °F
-----------------------	---------------	-----------------

### Recommended Storage Temperature

	0 °C to 50 °C	32 °F to 122 °F
--	---------------	-----------------

The electrode glass will shatter if shipped or stored at temperature below 0 °C (32 °F)

The performance life of the electrode will shorten if stored at temperatures above 50 °C (122 °F)

### Mounting

	Any angle is acceptable. Use with 3719 wet-tap assembly for mounting electrodes.	
--	--	--

### Shipping Weight

	0.2 kg	0.4 lb
--	--------	--------

### Standards and Approvals

	Manufactured under ISO 9001 for Quality	
--	---	--

# Dimensions

## Assembly 3719-1X

For pipe sizes up to 4 in.

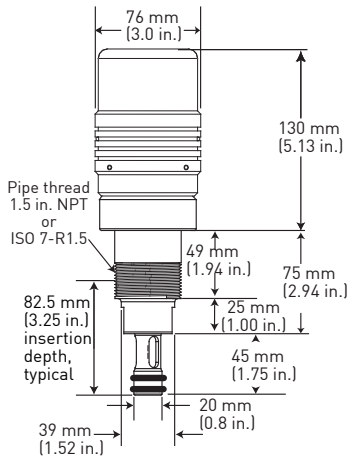

## Assembly 3719-2X

For pipe sizes 6 to 12 in.

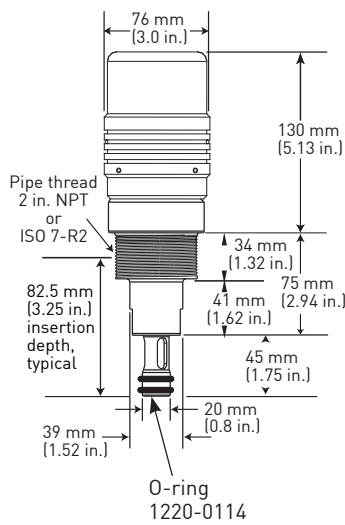

## Electrodes 3-2756 Wet-Tap pH, 3-2757 Wet-Tap ORP

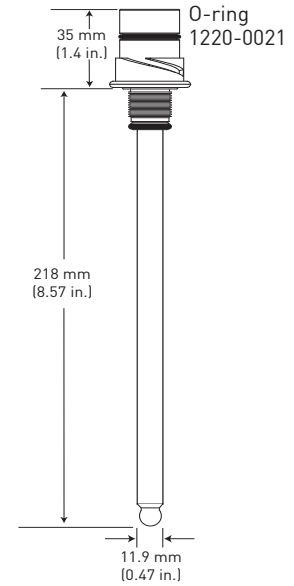

### Product selection Guide:

- Step 1 - Choose Sensor
- Step 2 - Choose preamplifier or sensor electronics
- Step 3 - Choose Wet-Tap assembly
- Step 4 - Choose a customer supplied mounting option

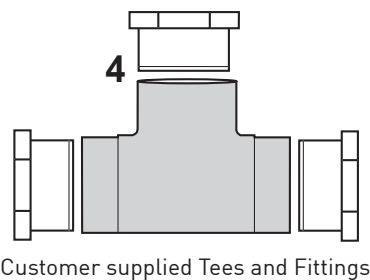
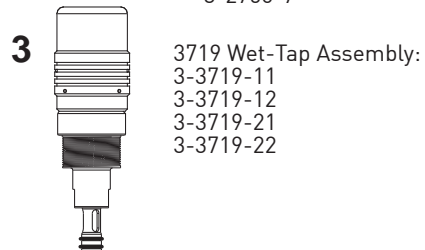
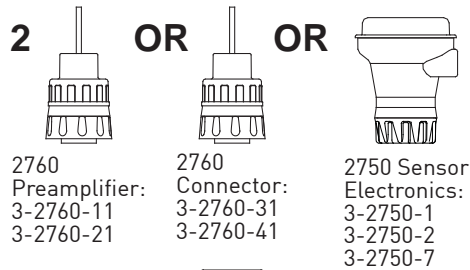
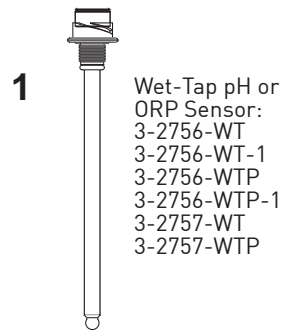

# Operating Temperature/Pressure Graph

**Note:**

The pressure/temperature graphs are specifically for the Signet sensor. During system design the specifications of all components must be considered. In the case of a metal piping system, a plastic sensor will reduce the system specification.

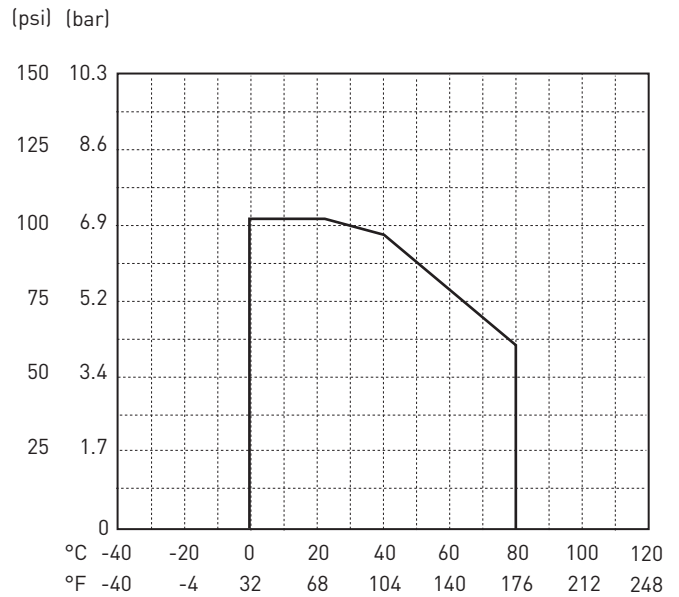

See Technical Reference section for assistance in choosing the correct sensor.

## Ordering Information

**Wet-Tap Assembly**

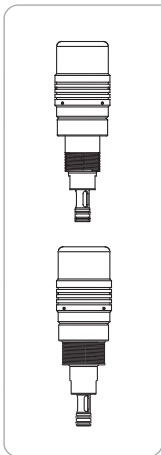

Mfr. Part No.	Code	Process Thread Connection	for pipe size
3-3719-11	<b>159 000 804</b>	1½ inch NPT	2½ to 4 in.
3-3719-12	<b>159 000 806</b>	ISO 7/1-R 1.5	2½ to 4 in.
3-3719-21	<b>159 000 805</b>	2 inch NPT	6 to 12 in. pipes
3-3719-22	<b>159 000 807</b>	ISO 7/1-R 2	6 to 12 in. pipes

**Model 3719**

**Ordering Information**

- 1) Use a mounting saddle or a standard threaded part to mount Wet-Tap assembly.
- 2) ASTM fittings are available to order; metric fittings are customer supplied.
- 3) Use -11 or -12 versions for pipe sizes up to 4 in.
- 4) Use -21 or -22 versions for pipe sizes 6 to 12 inches.

## Ordering Information

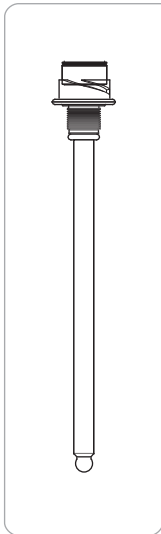

Mfr. Part No.	Code	Electrode Material	Temperature Element	Use with
DryLoc® pH Electrodes				
3-2756-WT	<b>159 000 834</b>	glass	PT1000	2750 Sensor Electronics*
3-2756-WT-1	<b>159 001 383</b>	glass	3 KΩ Balco	2760 Preamplifier**
3-2756-WTP	<b>159 001 390</b>	plastic	PT1000	2750 Sensor Electronics*
3-2756-WTP-1	<b>159 001 384</b>	plastic	3 KΩ Balco	2760 Preamplifier**
DryLoc® ORP Electrodes				
3-2757-WT	<b>159 000 835</b>	glass	N/A	2750 Sensor Electronics* or 2760 Preamplifier**
3-2757-WTP	<b>159 001 391</b>	plastic	N/A	2750 Sensor Electronics* or 2760 Preamplifier**

\*The 2750 sensor electronics has a digital (S<sup>3</sup>L) output which is used with the 8900 or 9900 instruments. It also has a 4 to 20 mA output for connections to PLC's, data recorders, etc.

\*\*The 2760 preamplifier is used for connection directly to the 8750 Transmitter and other analog transmitters.

### Model 2756-2757

#### Ordering Notes

- 1) pH and ORP electrodes require connection to model 2750-1 or -2 or 2760-X1.

## Accessories and Replacement Parts

Mfr. Part No.	Code	Description
3-2700.395	<b>159 001 605</b>	Calibration kit: includes 3 polypropylene cups, box used as cup stand, 1 pint pH 4.01, 1 pint pH 7.00
3822-7115	<b>159 001 606</b>	20 gm bottle quinhydrone for ORP calibration (must use pH 4.01 and/or pH 7.00 buffer solutions)
<b>Other</b>		
1220-0114	<b>159 000 854</b>	3719 O-ring, FPM (spare part)
3-3719.390	<b>159 000 855</b>	3719 locking shroud (spare part)
1220-0021	<b>198 801 186</b>	O-ring, FPM
1224-0114	<b>159 000 854</b>	3719 O-ring, FPM
3-0700.390	<b>198 864 403</b>	pH buffer kit (1 each 4, 7, 10 pH buffer in powder form, makes 50 ml of each)
3822-7004	<b>159 001 581</b>	pH 4 buffer solution, 1 pint (473 ml) bottle
3822-7007	<b>159 001 582</b>	pH 7 buffer solution, 1 pint (473 ml) bottle
3822-7010	<b>159 001 583</b>	pH 10 buffer solution, 1 pint (473 ml) bottle

### 3-3719.099 Rev F (5/13)